



ISO 9001



Burner Controls

LOK16... LGK16...

Series...A...

Burner controls with self-checking flame signal amplifier, for continuously operating multistage or modulating oil or gas burners of medium to high capacity; with air pressure supervision for checked air damper control.

The LOK16... / LGK16... and this Data Sheet are intended for OEMs which integrate the burner controls in their products.

Use

Burner controls type LOK16... / LGK16... feature a self-checking flame supervision circuit.

That supervision circuit initiates the required safety actions not only in the case of premature or missing flame signals, but also in the event of any kind of fault on the flame detector, the detector cables or the flame signal amplifier that could simulate a flame signal during burner operation.

The burner controls are therefore suited for use in all types of oil- or gas-fired combustion plants where self-checking flame supervision systems are either mandatory or recommendable:

- Burners that operate continuously
- Burners in intermittent operation that, in the case of great heat demand, may operate continuously for more than 14 hours, e.g. in plants using boiler sequencing
- Burners that need to comply with the German TRD 411 and TRD 412 regulations for steam boilers
- Burners in plants where, for specific safety requirements, supervision of the burner by a self-checking flame supervision system seems advisable

- The control sequence and the connection circuitry of the LOK16... / LGK16... burner controls are identical to those of the LAL2... and LFL1... respectively (with the exception of type LFL1.148), so that existing combustion plants can also be equipped with self-checking burner controls,
 - provided very good flame detector current values are measured in the plant supervised so far by the LFL1..., and
 - provided the following types of flame detectors are either installed or can subsequently be fitted:

Specific features when using LOK16...

- Selenium photocell detector RAR...

Specific features when using LGK16...

- Flame detector QRA53... / QRA55...
- Ionization probe
- Flame detector QRA53... / QRA55... together with ionization probe, e.g. in the case of burners with pilot burner (also refer to Data Sheet 7712)

Warning notes



To avoid injury to persons, damage to property or the environment, the following warning notes should be observed!

Do not open, interfere with or modify the unit!

- Before performing any wiring changes in the connection area of the LOK16... / LGK16..., completely isolate the burner control from the mains supply (all-polar disconnection)
- Ensure protection against electric shock hazard by providing adequate protection for the burner control's terminals
- Prior to commissioning and after changing fuses, check wiring and all safety functions
- Fall or shock can adversely affect the safety functions. Such units may not be put into operation, even if they do not exhibit any damage
- The flame detector current measuring unit KF8832 is not suited for continuous operation
- **Do not press the lockout reset button on the unit or the remote reset button (input 21) for more than 10 seconds, since this would damage the lockout relay inside the unit**

Mounting notes

- Ensure that the relevant national safety regulations are complied with

Upgrading existing plant

When changing plants to LOK16... or LGK16..., the existing LAL... or LFL... base must be secured by a cylinder-shaped grooved pin, thus ensuring that only an LOK16... or LGK16... type burner control can be fitted.

Part number of grooved pin: 4 166 8024 0

Location of grooved pin:

Between terminals 10 and 11 of the LAL... base, and between terminals 4 and 5 of the LFL... base.

Start repetition in the event of loss of flame

By removing link «B» on the underside of the unit, the LOK16... can be switched to start repetition in the event of loss of flame during operation.

In that case, the wire link must be cut off completely.

But it must be checked whether this is in compliance with national standards and regulations.

Installation notes

- Installation work must be carried out by qualified staff
- Neutral conductors may not be interchanged

Electrical connection of ionization probe and flame detector

It is important to achieve practically disturbance- and loss-free signal transmission:

- Never run the detector cable together with other cables
 - Line capacitance reduces the magnitude of the flame signal
 - Use a separate cable
- Observe the permissible detector cable lengths (refer to «Technical data»)
- It is not permitted to connect 2 flame detectors QRA53... / QRA55... in parallel
- When using the QRA53... / QRA55..., earthing of terminal 22 is mandatory
- The ionization probe is not protected against electric shock hazard
- Locate the ignition electrode and ionization probe such that the ignition spark cannot arc over to the ionization probe (risk of electrical overloads)
- Always run the ignition cables separately while observing the greatest possible distance to the unit and to other cables
- Supervision with ionization probe and flame detector QRA... is possible but, for safety reasons, both may not be active at the same time, with the exception of the second safety time «t9». At the end of the second safety time, one of the detected flames must extinguish, e.g. by shutting down the pilot gas valve connected to terminal 17

Commissioning notes

- Commissioning and maintenance work must be carried out by qualified staff
- When commissioning the plant or when doing maintenance work, make the following safety checks:

	Safety check	Anticipated response
a)	Burner startup with flame detector darkened	Lockout at the end of «TSA»
b)	Burner startup with simulated flame	Lockout after 40 seconds at the latest
c)	Burner operation with simulated loss of flame; for that purpose, darken the flame detector in operation and leave it in that state	- LOK16... with wire link cut: start repetition followed by lockout at the end of «TSA» - LGK16... and LOK16... with wire link closed: immediate lockout
d)	Burner startup with response of air pressure monitor	Prevention of startup / lockout during «t1»
e)	Burner operation with simulated air pressure failure	Immediate lockout

Disposal notes



The unit contains electrical and electronic components and may not be disposed of together with household garbage.
Local and currently valid legislation must be observed.

Mechanical design

The burner controls are of plug-in design.
Housing and plug-in base are made of shock- and heat-resistant black plastic.
The lockout indicator, fault signal lamp and lockout reset button are located in the unit's viewing window.
The burner control has an exchangeable unit fuse and a spare fuse.

Type summary

The switching times are given in seconds, in the order of the startup sequence, valid for a frequency of 50 Hz. At 60 Hz, the times are about 20 % shorter. The type references apply to burner controls operating on AC 230 V, 50...60 Hz.

* For burner controls operating on AC 100...110 V, 50...60 Hz, the last 2 digits of the type reference read «17» in place of «27».



LOK16...

For flame supervision with a selenium photocell detector RAR7... or RAR8... for oil burners				Times
Preferred use:				
Flash-steam generators	Universal application	Medium- or heavy-oil burners		
	LOK16.140A27*	LOK16.250A27*	LOK16.650A27*	
t1	10	22.5	67.5	Prepurge time with air damper fully open
TSA	4	5	5	Safety time or first safety time with burners using a pilot burner
TSA'	---	---	---	Safety time or first safety time with burners using a pilot burner
t3	2	2.5	2.5	Preignition time
t3'	From startup command (with air pressure supervision: from receipt of air pressure signal)			Long preignition time
t3n	10	15	15	Postignition time (ignition transformer connected to terminal 15)
t4	8	7.5	7.5	Interval between start of «TSA» or «TSA'» and release of valve at terminal 19
t4'	---	---	---	Interval between start of «TSA» or «TSA'» and release of valve at terminal 19
t5	4	7.5	7.5	Interval between end of «t4» or «t4'» and release of load controller or valve at terminal 20
t6	10	15	15	Postpurge time (identical to permissible afterburn time «t13»)
t7	2	2.5	2.5	Switch-on delay of fan motor «M2»
t8	30	47.5	92.5	Duration of startup without «t11» and «t12»
t9	---	---	---	Second safety time with burners using a pilot burner
t10	6	10	10	Interval from startup to the beginning of the air pressure check
t11	Optional			Air damper running time to the fully open position
t12	Optional			Air damper running time to the low-fire position
t13				Permissible afterburn time
t16	4	5	5	Interval from startup to the open command for the air damper
t20	32	35	12.5	Interval to the self-shutdown of the sequence switch

LGK16...

For flame supervision with flame detector QRA53... / QRA55... or ionization probe							
	Preferred use:						
	Flash-steam generators	Flash-steam generators	D (also WLE), F	D, A	GB	F, I	B, NL
	LGK16.122A27*	LGK16.133A27	LGK16.322A27*	LGK16.333A27*	LGK16.335A27*	LGK16.622A27*	LGK16.635A27*
t1	10	9	36	31.5	37.5	66	67.5
TSA	2	3	2	3	2.5	2	2.5
TSA'	---	---	---	---	5	---	5
t3	4	3	4	6	5	4	5
t3'	---	---	---	---	2.5	---	2.5
t3n	---	---	---	---	---	---	---
t4	6	6	10	12	12.5	10	12.5
t4'	---	---	---	---	15	---	15
t5	4	3	10	12	12.5	10	12.5
t6	10	14.5	12	18	15	12	15
t7	2	3	2	3	2.5	2	2.5
t8	30	29	66	72	75	96	105
t9	2	3	2	3	5	2	5
t10	6	6	8	12	10	8	10
t11	Optional						
t12	Optional						
t16	4	3	4	6	5	4	5
t20	32	60	---	27	22.5	---	---

Ordering

Oil burners	Burner control without plug-in base AC 230 V*	Control sequence and connection diagram like	Preferred use
	LOK16.140A27*	LAL2.14	Flash-steam generators
	LOK16.250A27*	LAL2.25	Universal use
	LOK16.650A27*	LAL2.65	Heavy-oil burners
Gas, oil and dual-fuel burners (depending on type of flame detector used)	LGK16.122A27*	LFL1.122	Flash-steam generators
	LGK16.133A27	LFL1.133	Flash-steam generators
	LGK16.322A27*	LFL1.322	D (WLE), F
	LGK16.333A27*	LFL1.333	D, A
	LGK16.335A27*	LFL1.335	GB
	LGK16.622A27*	LFL1.622	I, F
	LGK16.635A27*	LFL1.635	B, NL
Plug-in base 	AGM16....:	Coding of the plug-in base only allows the use of LOK16...	
Plug-in base 	AGM17....:	Coding of the plug-in base only allows the use of LGK16...	
Flame detectors	RAR7... or RAR8....:	Selenium photocell detector (refer to Data Sheet 7713)	
Flame detectors	QRA...53... / QRA55....:	Self-checking flame detector (refer to Data Sheet 7712)	
Ionization probe	Supplied by the burner manufacturer		
Accessories for flame detectors	Refer to Data Sheet 7712		

* For burner controls operating on AC 100...110 V, 50...60 Hz, the last 2 digits of the type reference read «17» in place of «27».

Technical data

General unit data LOK16... / LGK16...	Mains voltage	AC 220 V -15 %...AC 240 V +10 % AC 100 V -15 %...AC 110 V +10 %
	Mains frequency	50...60 Hz ±6 %
	Power consumption	3.5 VA
	Primary fuse (external)	max. 16 A (slow)
	Unit fuse	T6,3H250V to IEC 60 127
	Perm. input current at terminal 1	5 A to VDE 0660 AC3
	Perm. current load of control terminals	4 A to VDE 0660 AC3
	Required switching capacity of switching devices	1 A, AC 250 V
	- Between terminals 4 and 5, 4 and 12	depending on loading of terminals 15, 16, 18,
	- Between terminals 4 and 14	19 (LGK16....: 16...19), min. 1 A, AC 250 V
	Mounting position	optional
	Degree of protection	IP 40
	Weight	
	- Burner control	approx. 1000 g
	- Plug-in base	approx. 165 g

Norms and standards

Environmental conditions

Transport	IEC 60 721-3-2
Climatic conditions	class 2K2
Mechanical conditions	class 2M2
Temperature range	-50...+60 °C
Humidity	< 95 % r.h.
Operation	IEC 60 721-3-3
Climatic conditions	class 3K5
Mechanical conditions	class 3M2
Temperature range	-20...+60 °C
Humidity	< 95 % r.h.



Condensation, formation of ice and ingress of water are not permitted!

CE conformity

According to the directives of the European Union

Electromagnetic compatibility EMC	89 / 336 EEC
Directives for gas-fired appliances	90 / 396 EEC
Low-voltage directive	73 / 23 EEC

Identification code to EN 298

F B / M L L X K

Flame supervision

	RAR... (LOK16...)	QRA5x.C... (LGK16...)	QRA5x.D... (LGK16...)	IONIS: (LGK16...)
Operating voltage (Terminal 23 or 24)	< DC 1 V ±10 %	AC 280 V ¹⁾ ±10 %	AC 280 V ¹⁾ ±10 %	AC 245 V ¹⁾ ±10 %
Minimum detector current required	DC 6 µA	DC 35 µA ²⁾	DC 120 µA ²⁾	DC 12 µA
Maximum possible detector current	DC 25 µA	DC 70 µA ²⁾	DC 270 µA ²⁾	DC 100 µA
Short-circuit current	---	---	---	approx. AC 300 µA
Maximum length of detector cable (laid separately)	100 m	³⁾	³⁾	60 m ⁴⁾

- 1) AC voltage, measured with no detector current at AC 230 V mains voltage. Internal resistance of measuring instrument 10 MΩ. The shutter of the flame detector QRA53... / QRA55... is powered by mains voltage
- 2) Also refer to the specification given on the KF8832 for measuring the detector current
- 3)
 - Detector cable laid in a minimum distance of 5 cm from other mains carrying cable:
 - As a multiple cable **max. 50 m**
 - With 5 single wires **max. 70 m**
 - With a screened 3-core control cable to terminals 3, 4 and 5 of the flame detector QRA53... / QRA55... and standard mains cable to terminals 1 and 2 **max. 15 m**
 - With 2 screened single-core coaxial cables (≤ 45 pF / m, e.g. RG 62) to terminals 3 and 4 of the flame detector QRA53... / QRA55... and standard mains cable to terminals 1, 2 and 5 **max. 60 m**
 - If possible, screening should be earthed at both ends
- 4) Longer cable distances are permitted when connecting low capacitance detector cables to terminal 24 of the burner control (especially against earthed wires!)

Function

Principle of self-supervision

In contrast to conventional amplifiers, the signal delivered by the flame detector is handled dynamically and not statically. The flame detector signal is converted to a sequence of control pulses and then fed to the flame relay circuit. The latter is designed such that the flame relay can only be energized by a flame signal of the described form. If the pulses change due to a faulty detector or faulty detector cables, the relay will be deenergized and the burner control triggers the required safety actions. In the case of UV supervision, it must also be ensured that self-ignition of the UV tube (e.g. due to ageing) does not simulate a flame signal. For that reason, the incident radiation at the UV cell is periodically interrupted by a shutter. In addition to the self-checking facility, the flame signal circuit is subjected to a functional test during the prepurge time. If it does not operate correctly, the startup sequence will be aborted or lockout initiated. Furthermore, if mains voltage drops to a level where the safe operation of the burner control is no longer ensured, the burner will automatically shut down. When mains voltage returns to the normal level, the burner control repeats the startup sequence. If the detector signals are only slightly above the minimum levels, such mains voltage fluctuations can also give rise to burner lockout however.

Prerequisites for burner startup

- The burner control is reset and in the start position (terminals 11 and 12 must be under voltage)
- The air damper is closed. End switch «z» for the fully closed position must feed voltage from terminal 11 to terminal 8
- All control contacts between terminals 12 and 5 (limit thermostat, control thermostat, etc.) must be closed

A Start

When «R» closes, the burner control's sequence switch starts running. At the same time, the fan motor connected to terminal 6 (only prepurging) receives voltage and, on completion of «t7», the fan motor or flue gas fan at terminal 7 (pre- and post-purging) also receives voltage. On completion of «t16», the control command to open the air damper is given via terminal 9. During the running time of the motor, the sequence switch does not operate, as terminal 8, via which the motor of the sequence switch first receives voltage, is not under voltage during that period of time. The sequence switch starts again and programs only after the air damper is fully open and end switch «a» has changed over to feed voltage to terminal 8.

t1 Prepurge time with air damper fully open (nominal amount of combustion air)

Shortly after the start of the prepurge time, air pressure monitor «LP» must change over, thus interrupting the current path between terminals 4 and 13. Otherwise, the burner control would go to lockout (start of air pressure check). At the same time, terminal 14 must be under voltage since this current path is used to power the ignition transformer and the fuel valves.

t3' With the LOK16..., an ignition transformer connected to terminal 15 is therefore switched on at this point in time (long preignition). If there is no «LP», the ignition transformer receives voltage already with the start command. On completion of the prepurge time, the burner control via terminal 10 runs the air damper into the low-fire position, which is determined by the changeover point of auxiliary switch «m». During the positioning time, the sequence switch stops again until terminal 8 receives voltage from «m».

t5 Interval

On completion of «t5», terminal 20 receives voltage. At the same time, control outputs 9 to 11 and input 8 are galvanically separated from the unit's control section, so that the latter is protected against reverse voltages from the load control circuit. The startup sequence of the burner control ends with the release of load controller «LR» at terminal 20. The sequence switch switches itself automatically off, depending on the time variant used, either immediately or after some so-called «idle steps», that is, without changing the contact positions.

Expanding flame burn-
ers with LOK16... or
LGK16...

t3 Short preignition time; followed by fuel released via terminal 18.

TSA Safety time (part load)

On completion of the safety time latest, a flame signal must be present at the input of the flame signal amplifier, or else the burner control will initiate lockout.

Only with LOK16...:

t3n Postignition time (provided the ignition transformer is connected to terminal 15).

t4 Interval until the fuel valve is released via terminal 19.

Interrupted pilot burner
with LGK16...

(Burners using a pilot burner)

t3 / t3' **Short preignition time**; followed by release of fuel for the pilot burner via terminal 17.

TSA / TSA' **First safety time** (ignition load)

On completion of the safety time latest, a flame signal must be present at the input of the flame signal amplifier, or else the burner control will initiate lockout.

t4 / t4' **Interval** until the fuel valve at terminal 19 is released (start load of the main burner).

Times «TSA'», «t3'» and «t4'» are only programmed by burner controls type LGK16.335... and LGK16.635...

t9 Second safety time

On completion of the safety time, the main burner must have been ignited by the pilot burner, since the pilot gas valve is closed on completion of «t9».

B Operating position of the burner

B-C Burner operation (generation of heat)

During burner operation, the load controller drives the air damper to the nominal load or low-fire position, depending on heat demand.

Here, the nominal load is released by auxiliary switch «v» in the air damper actuator.

C Controlled shutdown by «R»

In the case of controlled shutdown, the fuel valves are immediately closed and, at the same time, the sequence switch starts again to program the postpurge time.

t6 Postpurge time (postpurging with fan «M2» connected to terminal 7).

Shortly after the start of the postpurge time, voltage at terminal 10 is reinstated, so that the air damper is driven into the «MIN» position.

The full closing of the air damper starts only shortly before the completion of the postpurge time, initiated by the control signal on terminal 11, which also remains under voltage during the following burner off period.

D-A End of control sequence (= start position)

When, on completion of «t6», the sequence switch has reset the control contacts to their start positions, thereby switching itself off, the detector and flame simulation test is started again. However, during the burner off period, lockout can occur only if the faulty flame signal lasts a few seconds. Hence, short ignition pulses of the UV detector caused by cosmic radiation do not initiate lockout.

Control sequence in the event of fault

In case of any disturbance, the supply of fuel is immediately interrupted. At the same time, the sequence switch stops and thus the lockout indicator also.

The symbol appearing above the reading mark indicates the kind of fault:

- ◀ No start, because one of the contacts is not closed (also refer to «Prerequisites for burner startup») or lockout during or after completion of the control sequence due to extraneous light (e.g. flame not extinguished, leaking fuel valves, faulty flame supervision circuit, or similar).
- ▲ Abortion of startup sequence, because end switch «a» has not fed the OPEN signal to terminal 8. Terminals 6, 7 and 14 and, in case LOK16... is used, terminal 15, also remain under voltage until the fault is corrected.
- P Lockout, because the air pressure signal has not been received at the start of the air pressure check.
- Lockout due to a fault in the flame supervision circuit.
- ▼ Abortion of startup sequence, because auxiliary switch «m» has not delivered the positioning signal for the low-fire position to terminal 8. Terminals 6, 7 and 14 and, in case LOK16... is used, terminal 15, also remain under voltage until the fault is corrected.
- 1 Lockout, because no flame signal has been received on completion of the (first) safety time.
- 2 Only with LGK16...:
Lockout, because no flame signal has been received on completion of the second safety time (flame signal of the main flame with interrupted pilot burners).
- I Lockout, because the flame signal has been lost during burner operation or air pressure failure has occurred.

Only with LOK16...:

If wire link «B» has been cut off and the flame is lost during burner operation, the burner control programs a repetition of the startup sequence with the full program.

Lockout indication

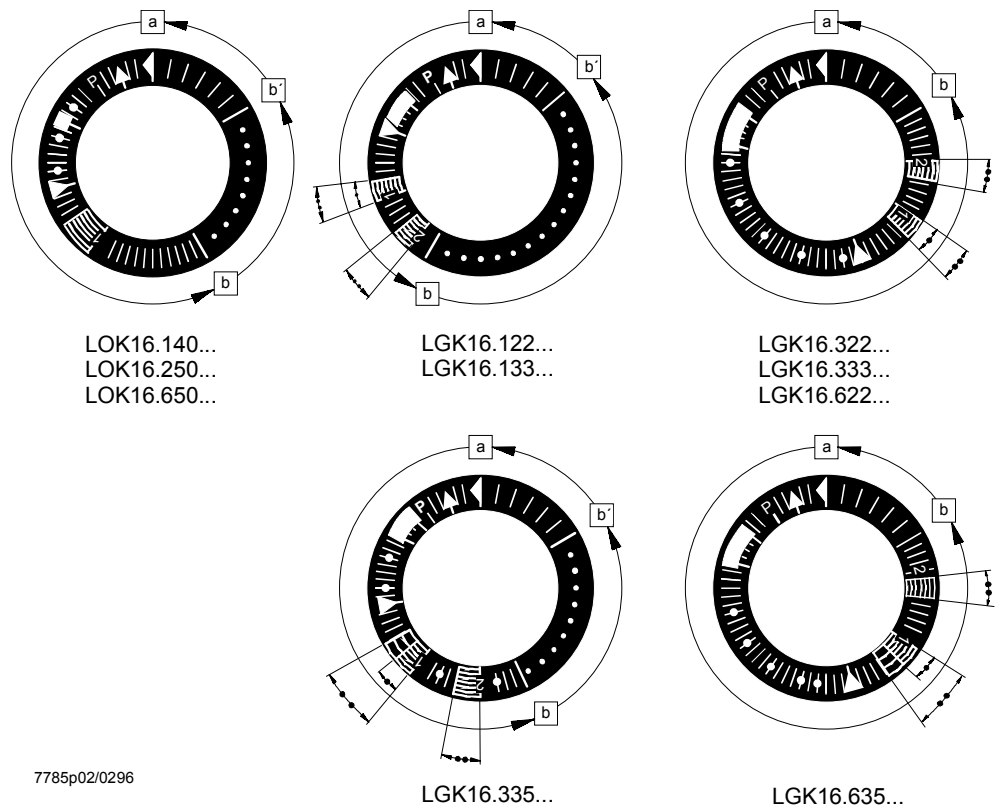

a-b Startup sequence

b-b' With some time variants:
 «Idle steps» of the sequence switch up to the self-shutdown after burner startup
 (b' = operating position of the sequence switch)

b(b')-a Postpurge sequence after the controlled shutdown.
 In start position «a», the sequence switch switches itself automatically off or immediately initiates another burner startup (e.g. after a fault has been corrected)

- Duration of safety time with expanding flame burners
- Duration of safety times with interrupted pilot burners

When lockout has occurred, the burner control can immediately be reset. After resetting, and also after correction of a fault which resulted in a shutdown, or after a mains failure, the sequence switch always runs to its start position, whereby only terminals 7, 9, 10 and 11 receive voltage in accordance with the control sequence. It is only then that the burner control programs a burner restart.

 Note: do not press the lockout reset button for more than 10 seconds.

Assignment of terminals

LOK16...

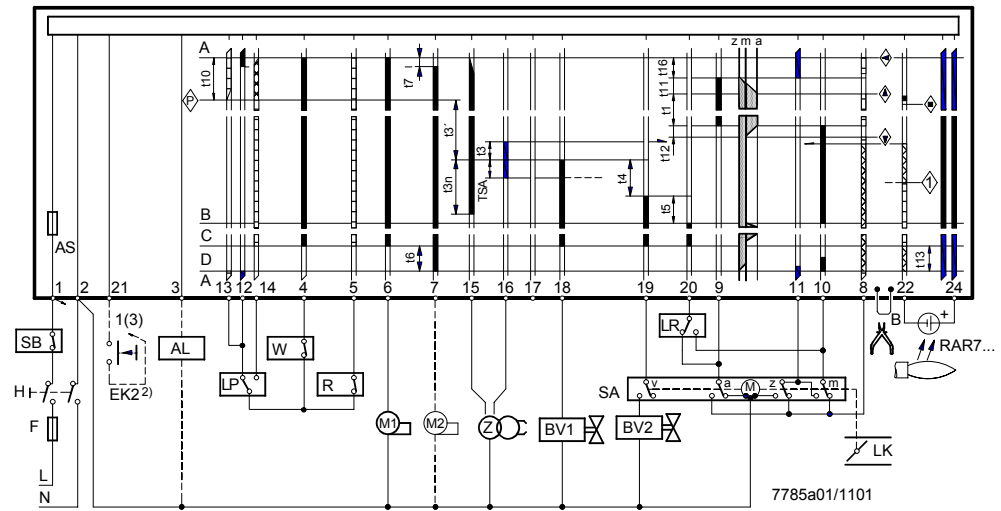

LGK16...

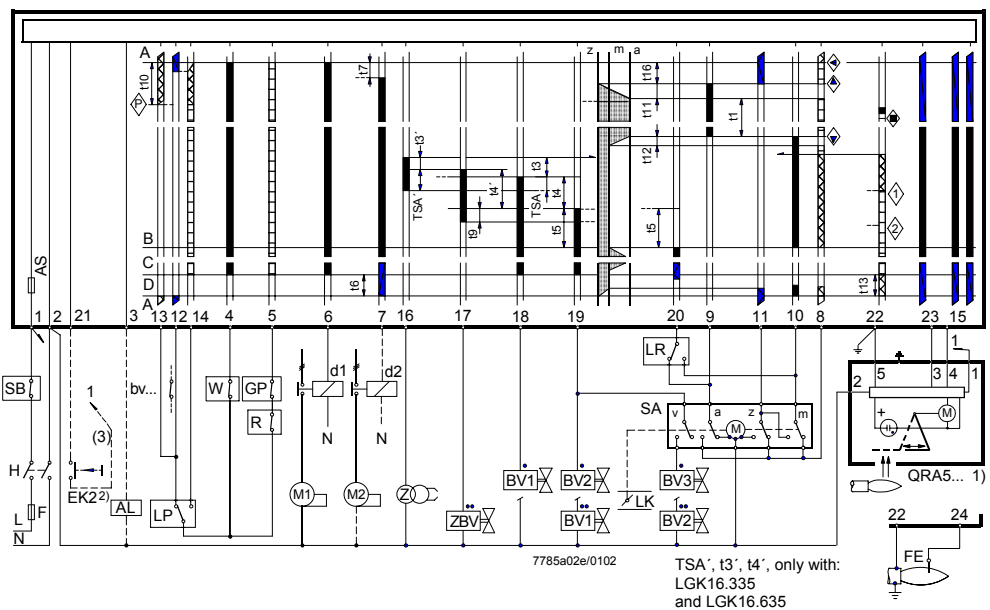



2) Do not press EK for more than 10 seconds

<p>Legend</p> <p>a Changeover end switch for air damper's fully open position</p> <p>AL Remote lockout warning device (alarm)</p> <p>AR Main relay (load relay) with «ar» contacts</p> <p>AS Unit fuse</p> <p>B Wire link (on the burner control's base)</p> <p>BR Lockout relay with «br» contacts</p> <p>BV... Fuel valve</p> <p>bv... Auxiliary contact in the valve actuator for the fully closed position check</p> <p>d... Contactor or relay</p> <p>EK... Lockout reset button</p> <p>F External safety switch</p> <p>FE Ionization probe</p> <p>FR Flame relay with «fr» contacts</p> <p>FS Flame signal</p> <p>GP Gas pressure monitor</p> <p>H Mains isolator</p> <p>L... Lockout warning lamp</p> <p>LK Air damper</p>	<p>LP Air pressure monitor</p> <p>LR Load controller</p> <p>m Auxiliary changeover switch for the air damper's MIN position</p> <p>M... Fan or burner motor</p> <p>NTC Resistor with negative temperature coefficient</p> <p>QRA... UV detector</p> <p>R Control thermostat or pressurestat</p> <p>RAR... Selenium photocell detector</p> <p>SA Air damper actuator</p> <p>SB Safety limit thermostat</p> <p>SM Synchronous motor of sequence switch</p> <p>v In the air damper actuator: auxiliary changeover switch for release of fuel as a function of the air damper position</p> <p>V Flame signal amplifier</p> <p>W Limit thermostat or pressure monitor</p> <p>z In the air damper actuator: end switch for the air damper's fully closed position</p> <p>Z Ignition transformer</p> <p>ZBV Pilot valve</p>
------------------------------------------------------------------------------------------------------------------------------------------------------------------------------------------------------------------------------------------------------------------------------------------------------------------------------------------------------------------------------------------------------------------------------------------------------------------------------------------------------------------------------------------------------------------------------------------------------------------------------------------------------------------------------------------------------------------------------------------	----------------------------------------------------------------------------------------------------------------------------------------------------------------------------------------------------------------------------------------------------------------------------------------------------------------------------------------------------------------------------------------------------------------------------------------------------------------------------------------------------------------------------------------------------------------------------------------------------------------------------------------------------------------------------------------------------------------------------------------------------------------------------------------------------------------------

A	Startup	C	Controlled shutdown
B	Operating position	D	End of control sequence

 Control signals delivered by the burner control

 Permissible input signals

 Required input signals:

If these signals are not present at the points in time marked by symbols or during the shaded periods of time, the burner control will interrupt the startup sequence or initiate lockout

- Valid for expanding flame burners
- Valid for burners with a pilot burner which is shut down after the main burner has ignited

- 1) When used with QRA53... / QRA55..., earthing of terminal 22 is mandatory
- 2) Do not press EK for more than 10 seconds

Lockout indication positions when there is no input signal (refer to «Control sequence in the event of faults»):

- ◀ No start
- ▲ Abortion of startup sequence
- ▼ Abortion of startup sequence
- Lockout (fault in the flame supervision circuit)
- 1 Lockout (no flame)
- 2 Lockout (no flame)
- P Lockout (no air pressure)

Time table

t1	Prepurge time with air damper fully open	t7	Switch-on delay for fan motor M2
TSA	Safety time or first safety time with burners using a pilot burner	t8	Duration of startup sequence excluding «t11» and «t12»
TSA´	Safety time or first safety time with burners using a pilot burner	t9	Second safety time with burners using a pilot burner
t3	Preignition time	t10	Interval from the start to the beginning of the air pressure check
t3´	Preignition time	t11	Running time of air damper into the fully open position
t3n	Post-ignition time (ignition transformer connected to terminal 15)	t12	Running time of air damper into the low-fire position
t4	Interval from the start of «TSA» or «TSA´» to the valve connected to terminal 19	t13	Permissible afterburn time
t4´	Interval from the start of «TSA» or «TSA´» to the release of the valve connected to terminal 19	t16	Interval from the start to the OPEN command for the air damper
t5	Interval from the end of «t4» or «t4´» to the release of the load controller or valve at terminal 20	t20	Interval to the self-shutdown of the sequence switch
t6	Postpurge time (identical with the permissible afterburn time «t13»)	max.	Safety time in the event of loss of flame during operation

* Times TSA´, t3´ and t4´ are only programmed by burner controls LGK16.335... and LGK16.635...

LGK16...

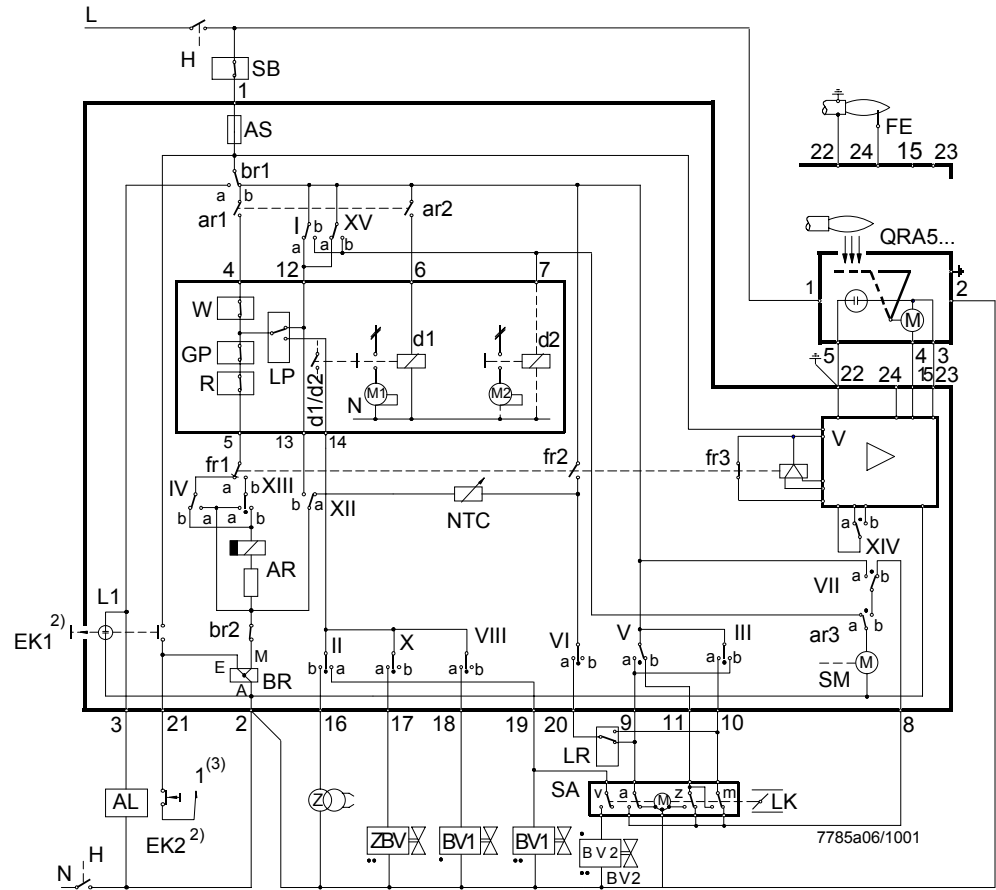

2) Do not press EK for more than 10 seconds

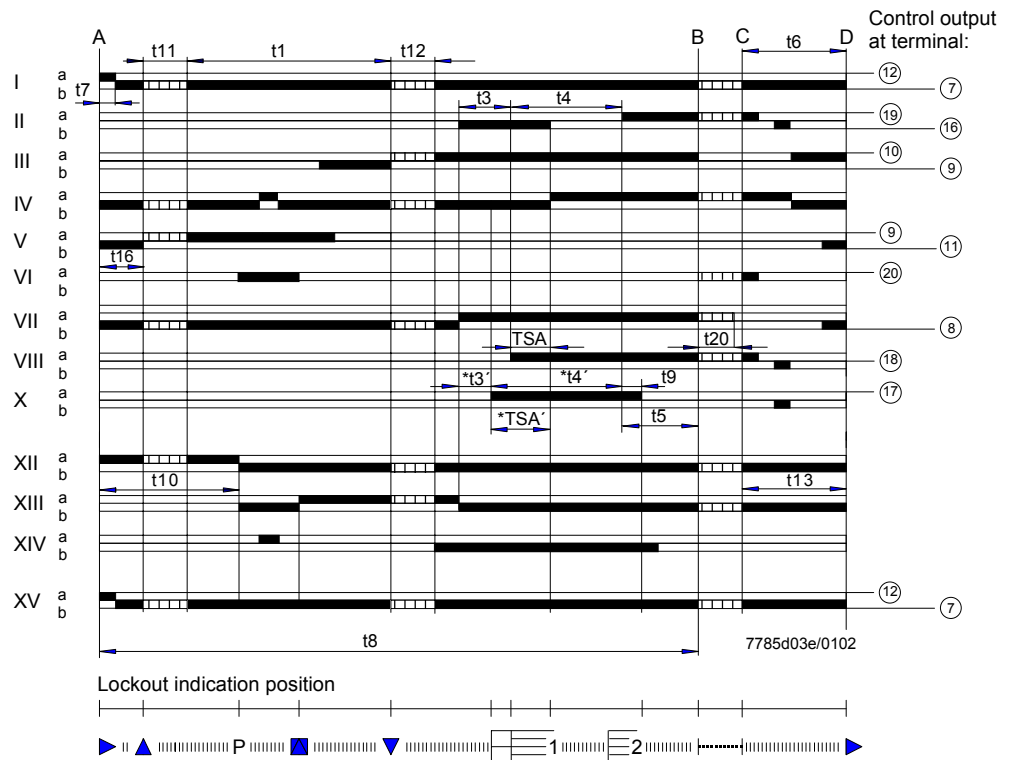

* Times TSA', t3' and t4' are only programmed by burner controls LGK16.335... and LGK16.635...

LOK16...

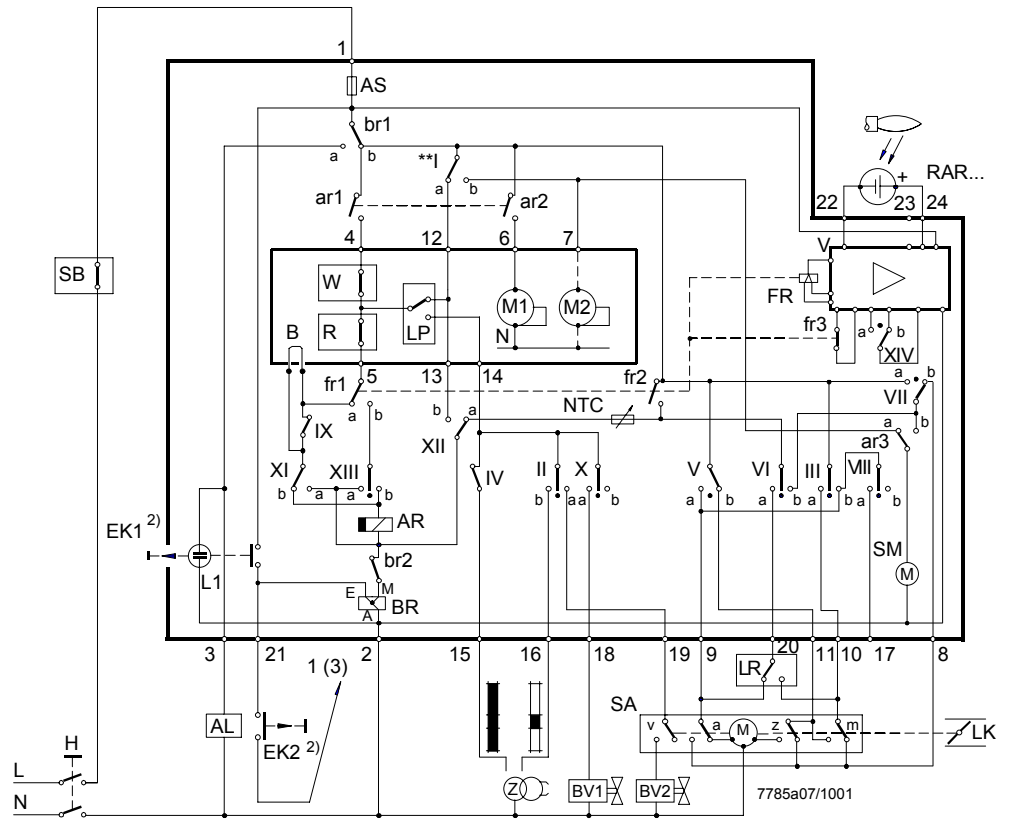

2) Do not press EK for more than 10 seconds

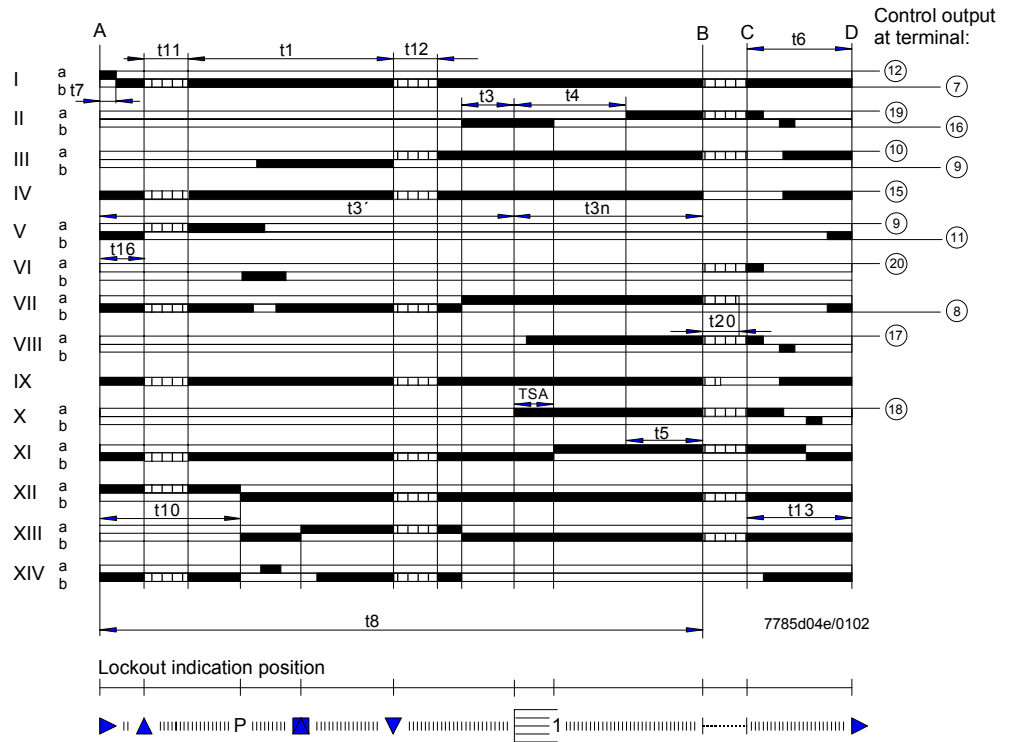

Connection examples

LGK16...

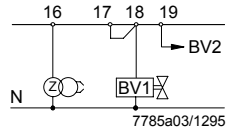

Doubling of safety time with expanding flame burners when using burner control LGK16.335... or LGK16.635...

By connecting terminals 17 and 18, the safety time is doubled and the preignition time reduced by 50 %. Before using this circuit, it must be ensured that the longer safety time is in compliance with national standards and regulations!

LOK16...

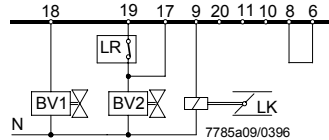

Control of the air damper actuator during operation by feeding control signals to terminal 17

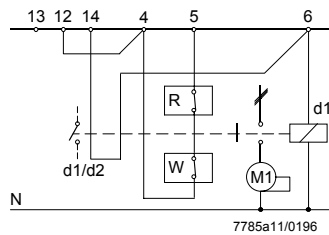

Wiring required for operation without air pressure supervision

If an auxiliary contact of the fan contactor is included in the circuit as shown in the diagram, ignition and fuel release are possible only when the contact is closed.

LOK16... / LGK16...

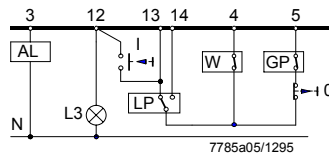

Semiautomatic startup

The burner is switched on manually by pressing button «I».

Then, the burner control programs the startup sequence and flame supervision.

The burner is switched off manually by pressing button «0», or automatically by the limit thermostat or pressure monitor «W», or by gas pressure monitor «GP».

«L3» indicates when the burner control is ready to be started; it extinguishes shortly after the burner is switched on.

For the other connections, refer to the connection diagrams.

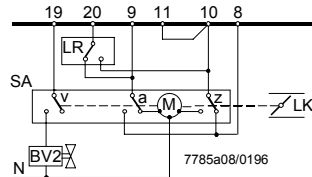

Connection of air damper actuators without changeover end switch for the fully closed position.

«Z» is set to low-fire

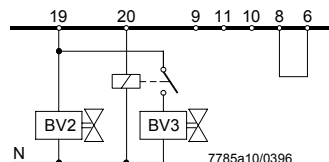

Control of a fuel valve by terminal 20 in the case of burners without air damper or with an air damper not controlled by the burner control.

The relay is not required if the valve connected to terminal 20 is hydraulically series-connected to a valve controlled by terminal 18 or 19.

If no air damper actuator is used, terminal 8 must be connected to terminal 6.

Detector current measurement

LOK16... / RAR...

The measuring instrument must be connected between the detector and terminal 22 (+pole to terminal 22).

LGK16... / QRA53... /
QRA55...

Use the KF8832 measuring instrument (not suited for continuous operation).
There is no self-checking while measurements are made.
The KF8832 is not required when using the QRA5x.D...

LGK16... / detector
electrode

The measuring instrument must be connected between terminal 24 and the detector
electrode (+pole to terminal 24).

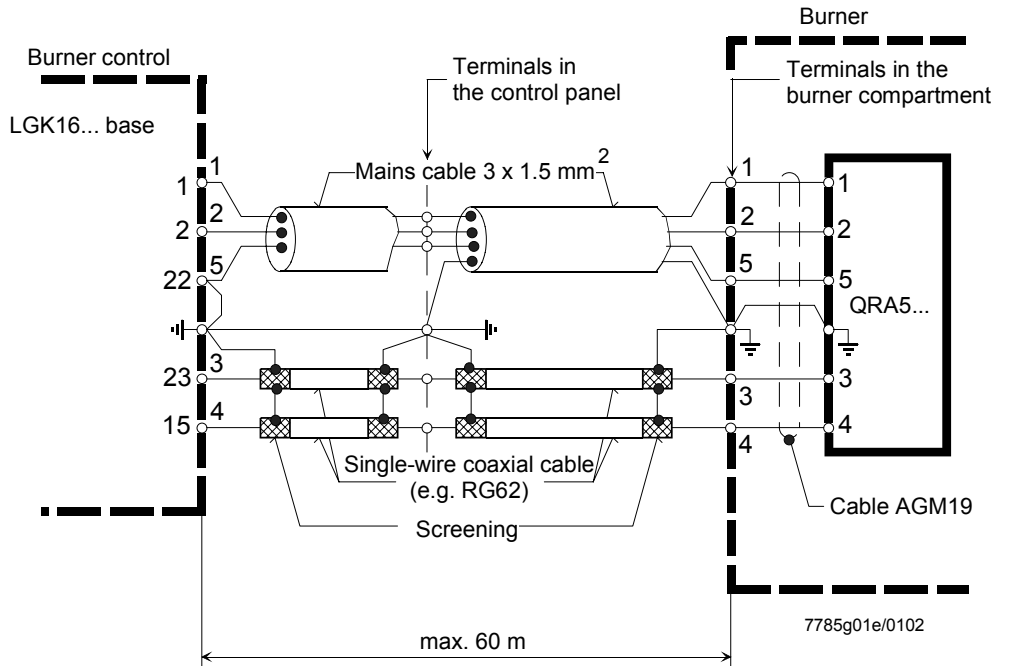

With QRA5x.C...

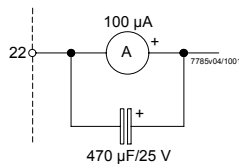

With QRA5x.D...

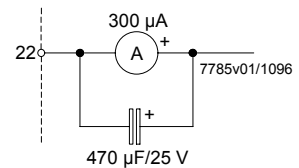

With RAR...

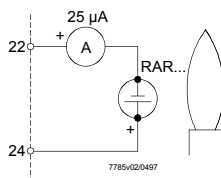

With ionization

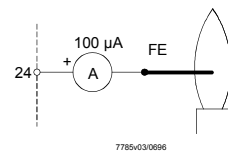

Legend

A Ammeter
RAR... Selenium photocell detector
FE Ionization probe

Program sequence

Expanding flame burners (burners without a pilot burner), controlled and supervised by LOK16... or LGK16...

Air damper in low-fire position during burner off times (min.).

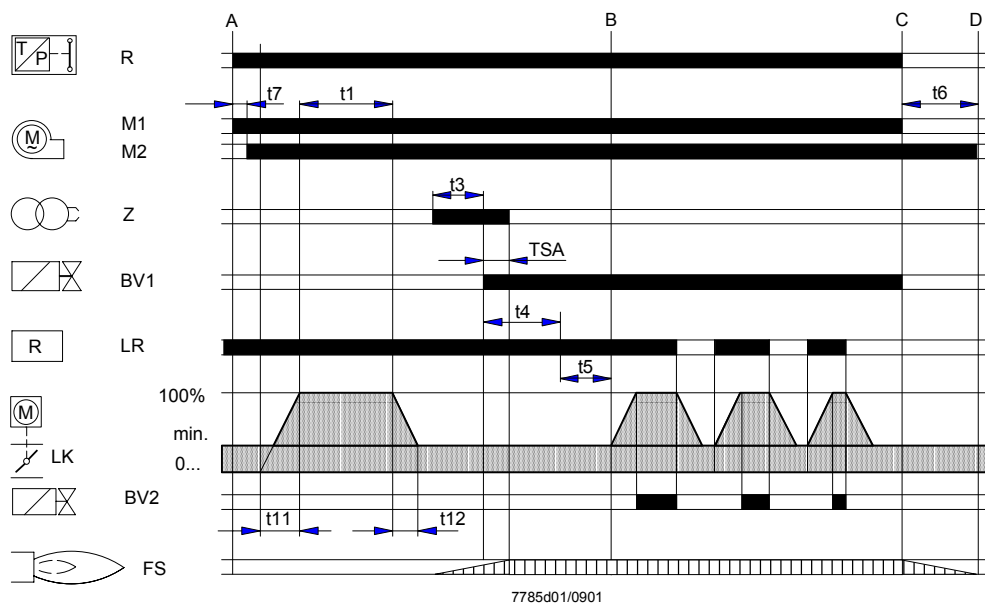

Interrupted pilot burners (burners with pilot burner), controlled and supervised by LGK16.335 or LGK16.635, for example.

The other types of burner controls of the LGK16... range program the times «TSA», «t3», «t4» and «t9» for the pilot burner.

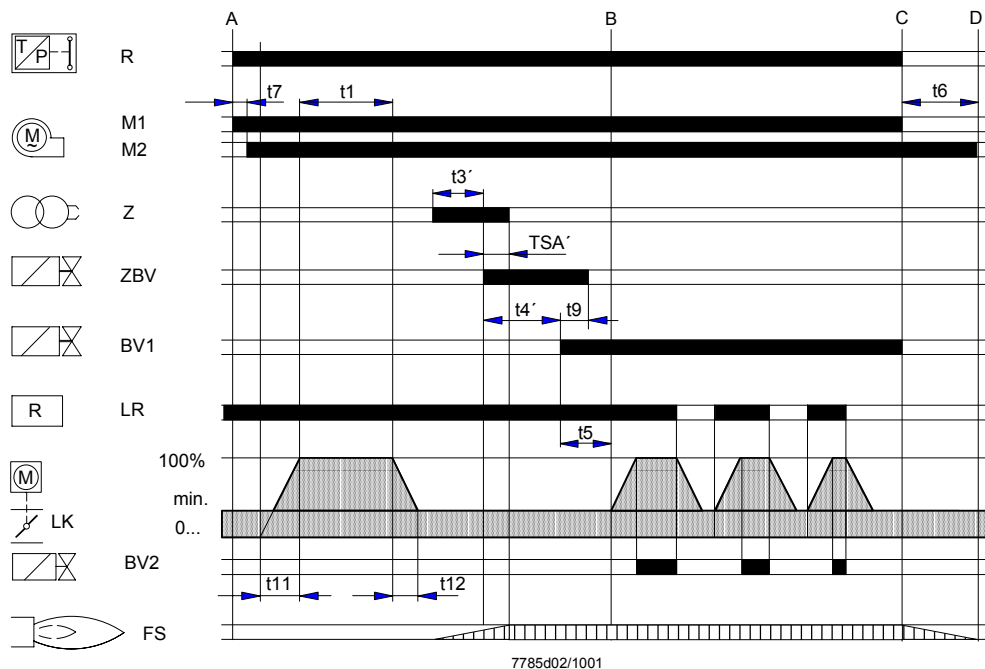

Dimensions

Dimensions in mm

LOK16... / LGK16...
with plug-in base
AGM...

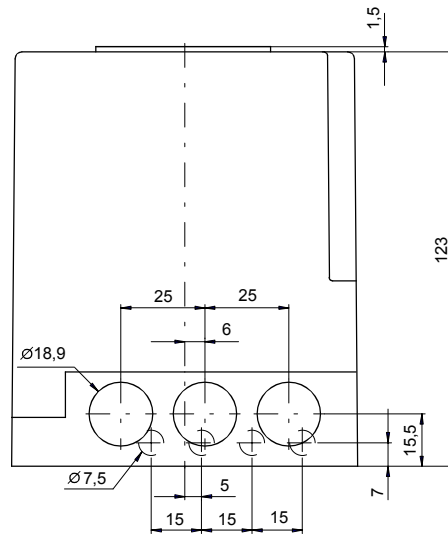

7785m02/0296

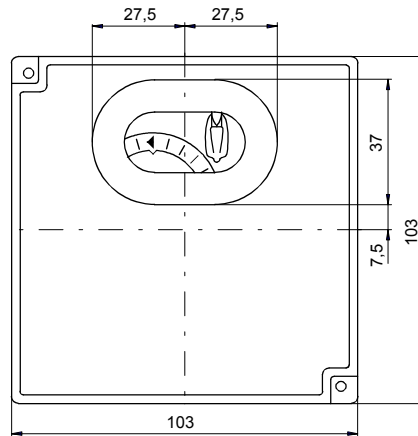

AGM16... or AGM17...

